

# HD Analog Camera

## Quick Installation Guide

### 1 Camera Connection Diagram

Connecting cables

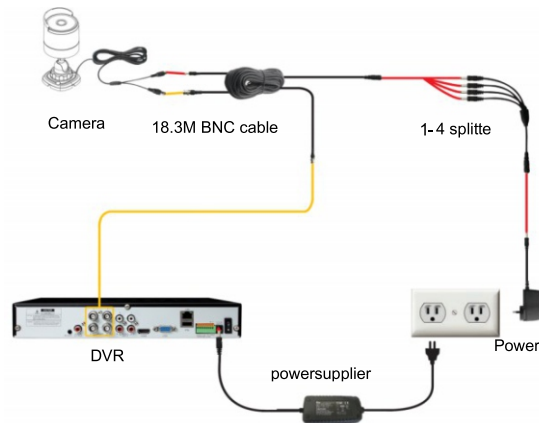

CAUTION

RISK OF EXPLOSION IF BATTERY IS REPLACED BY AN INCORRECT TYPE

DISPOSE OF USED BATTERIES ACCORDING TO THE INSTRUCTIONS

01

### 2 Installation

Bullet Camera Installation

Ceiling Mounting

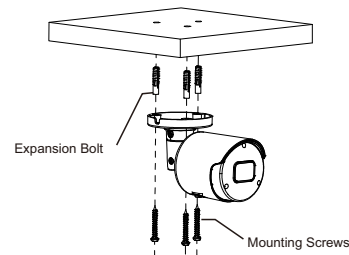

Insert three expansion bolts in place into the ceiling and fix the equipment with three mounting screws.

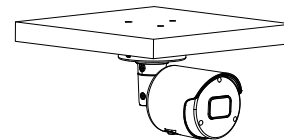

02

Dome Camera Installation

Ceiling Mounting

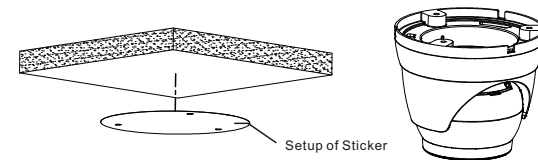

Paste the sticker in place at the proper position as selected.

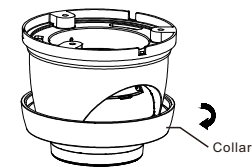

Remove the collar off the camera by rotating it down

03

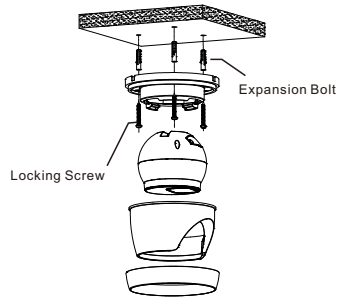

Fix the pedestal by drilling locking holes around the sticker and inserting three expansion bolts into the holes and fastening it with three locking screws.

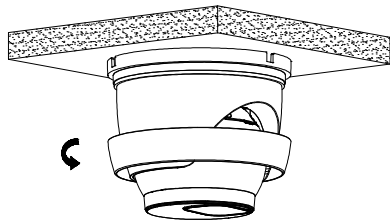

Mount the collar back by rotating it up

04

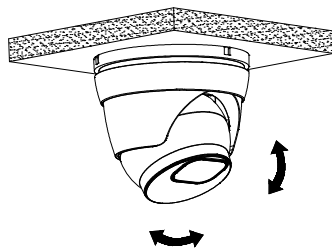

Adjust it to an appropriate angle.

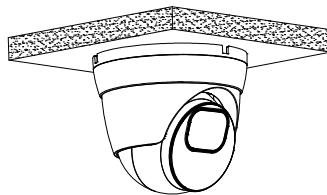

Completion of Installation

05

## Vandal-Proof Dome Camera Installation

Ceiling Mounting

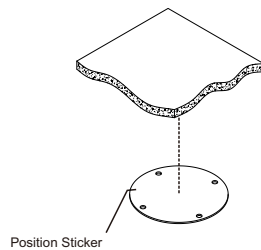

Apply the position sticker to the desired camera mounting position.

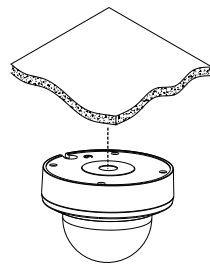

06

## Cover Component

Remove the cover component by loosening the three locking screws with the included hex wrench.

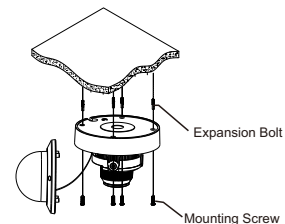

Use the position indicated on the position sticker to drill the holes needed to mount the camera base. Insert the expansion bolt into the holes. Match the base's mount openings to the expansion bolts position, then place the mounting screws through the base's mount opening into the expansion bolt. Tighten the mounting screws to ensure the camera base mounted securely.

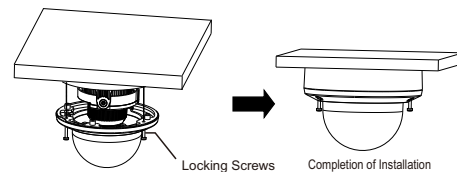

- ※ Place the cover component back onto the base.
- ※ Please make sure the locking screw position on the cover component matches the locking post on the base.
- ※ Tighten the locking screws after the cover component is in the correct position.

07